

# McKesson Printing Services Catalog

*Helping you grow your pharmacy's business  
and improve your brand recognition*

Rx Label, Forms and Supplies

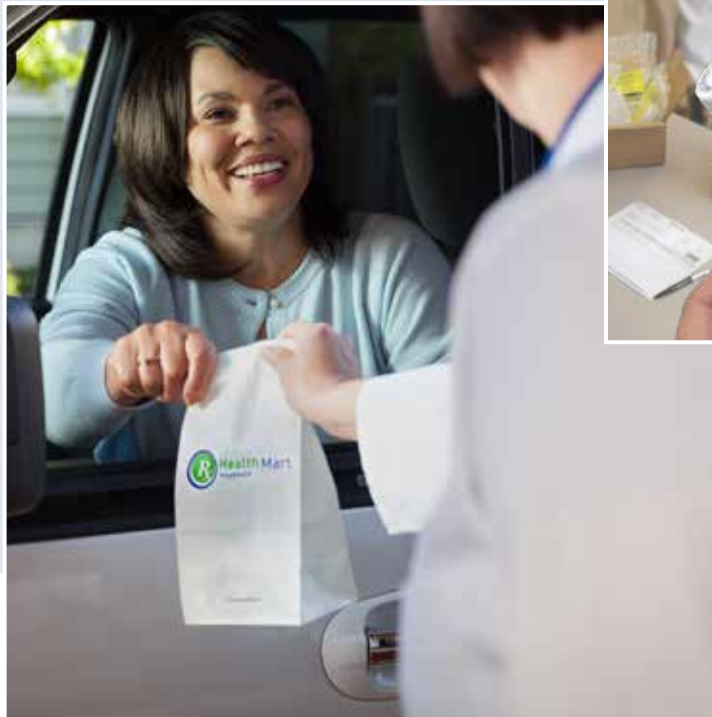

Patient  
Engagement



Care  
Continuum



Prescription  
Management



Business  
Operations

# McKesson Printing Services

Let us help you achieve a professional, high-quality look to the printed products that accompany your prescription fills. We are here to help you save time and money on your printed products and supplies. Regardless of which pharmacy system you use, we can be your single source supplier, enabling you to spend less time worrying about office supplies and more time with your patients.

## Our products include:

- Custom-branded thermal and laser label
- Custom-branded prescription bags
- Monograph Receipts
- LTC and A/R Forms
- Supplies: laser printer toner cartridges, prescription pads, POS paper and ribbons

## Convenient Ways for You to Order

### New Orders:

**Call:** 800.289.2192, Opt 3

**Email:** MPTSBusinessServices@McKesson.com

### Reorders:

**Call:** 866.950.8738

**Fax:** 844.614.6085

**Email:** MPSPrintingServices@McKesson.com



*“McKesson Printing Services is like my own personal marketing department. They are able to customize my products with my own logo and tagline which helps me compete more effectively with chains. I value the service that McKesson Printing Services supplies since I don’t have the time or the creativity to do this on my own.”*

*Jonathan Brunswig  
Owner*

*Scott City Health Mart Pharmacy*

# Table of Contents

*Click on each category to take you directly to that page.*

Sales Process for Customized Products..... 4

Direct Thermal Rx Labels ..... 5–8

Full Page Laser Rx Labels ..... 9–10

Automation Prescription Labels..... 11

Back Tags..... 12

Long Term Care Labels & License Plates ..... 12

Monograph Receipts..... 13

Accounts Receivable Forms and Envelopes ..... 14–15

Long Term Care Forms..... 16–18

Printer Supplies and Toner Cartridges..... 19

Supplies and Prescription Pads ..... 20

Prescription Bags ..... 21

Compliance Packaging ..... 22–23

Custom Label and Art Design..... 24



# Sales Process for Customized Products

1. Call or email our Printing Services Team.
2. Send us a picture or sample of your current product for our review and we will provide you with a quote.
3. A proof will be developed by our design team and sent to you for approval.
4. Your order will ship in approximately 6 weeks from the proof approval date.

**Please note:**

A *Compatible Systems Number Key* (shown below) accompanies some of our products in this catalog. This key is intended as a guide to help you identify products that may work with your pharmacy management software. The key is based on label styles we have seen other customers order. It is your responsibility to contact your software provider to obtain verification that your software will support your chosen product.

**Compatible Systems**

- |                  |                    |                |
|------------------|--------------------|----------------|
| 1 = EnterpriseRx | 5 = Datascan       | 9 = OPUS       |
| 2 = Liberty      | 6 = DigitalRx      | 10 = PioneerRx |
| 3 = Express Rx   | 7 = HBS            | 11 = QS1       |
| 4 = ComputerRx   | 8 = Micro Merchant | 12 = Rx30      |

## Convenient Ways for You to Order

**New Orders:**

**Call:** 800.289.2192, Opt 3

**Email:** [MPTSBusinessServices@McKesson.com](mailto:MPTSBusinessServices@McKesson.com)

**Reorders:**

**Call:** 866.950.8738

**Fax:** 844.614.6085

**Email:** [MPSPrintingServices@McKesson.com](mailto:MPSPrintingServices@McKesson.com)



# Direct Thermal Rx Labels

If you are not using thermal labels, here's why you should consider the switch...

- Easy to Use—thermal printing provides quick loading label rolls, which means no more manually loading label into trays!
- Save Time and Money—a simple design with less moving parts than a traditional laser label printer. With thermal printing there is no need for you to buy toner to print label and your printer is less likely to jam or malfunction.
- Improve Patient Interaction—free up time for patient care and consultation!

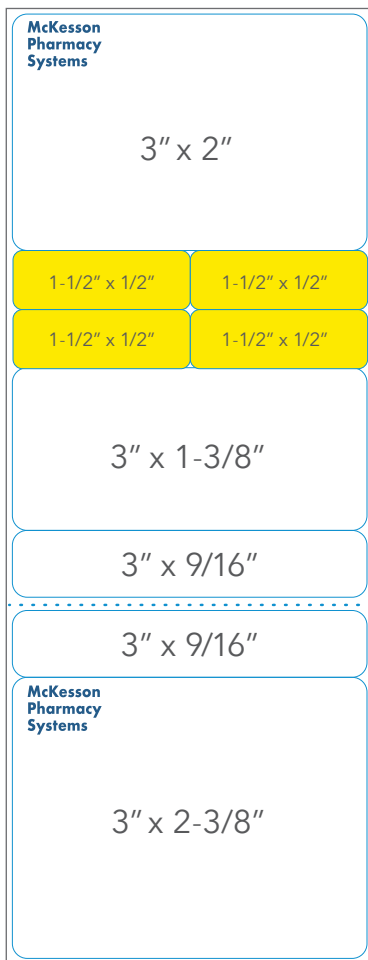

**DTRX-704** ① ② ⑦ ⑧  
 3-1/8" x 8-1/8"  
 350 labels per roll  
 6,300 labels per case

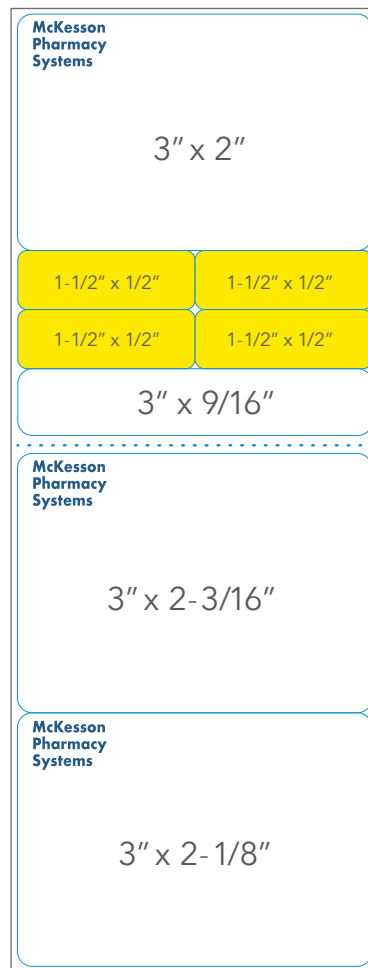

**DTRX-705** ① ②  
 3-1/8" x 8-1/8"  
 350 labels per roll  
 6,300 labels per case

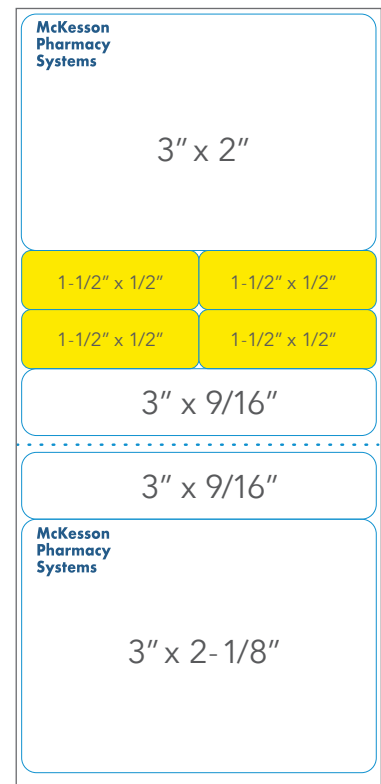

**DTRX-706** ① ②  
 3-1/8" x 6-1/2"  
 450 labels per roll  
 8,100 labels per case

Compatible Systems		
① = EnterpriseRx	⑤ = Datascan	⑨ = OPUS
② = Liberty	⑥ = DigitalRx	⑩ = PioneerRx
③ = Express Rx	⑦ = HBS	⑪ = QS1
④ = ComputerRx	⑧ = Micro Merchant	⑫ = Rx30

# Direct Thermal Rx Labels

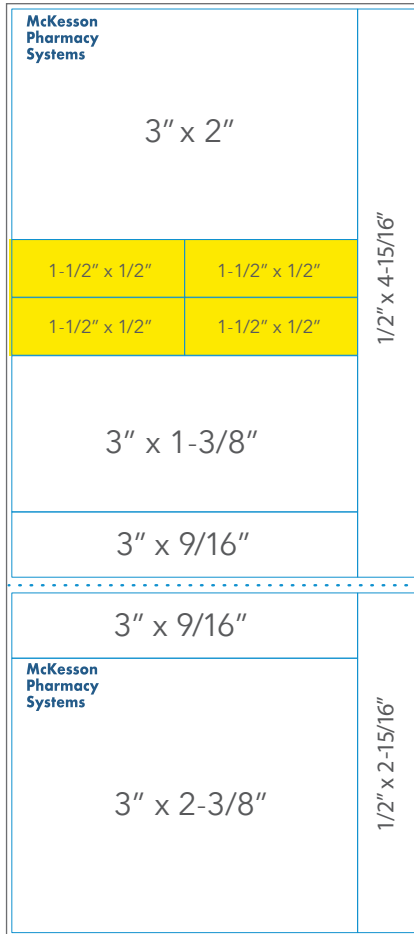

**DTRX-707** **2**  
 3-1/2" x 8-1/8"  
 350 labels per roll  
 4,200 labels per case

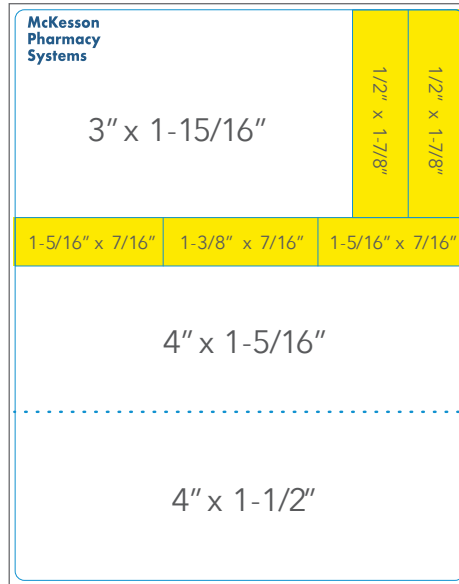

**DTRX-783** **2 4 6 8**  
 4" x 5-1/8"  
 500 labels per roll  
 6,000 labels per case

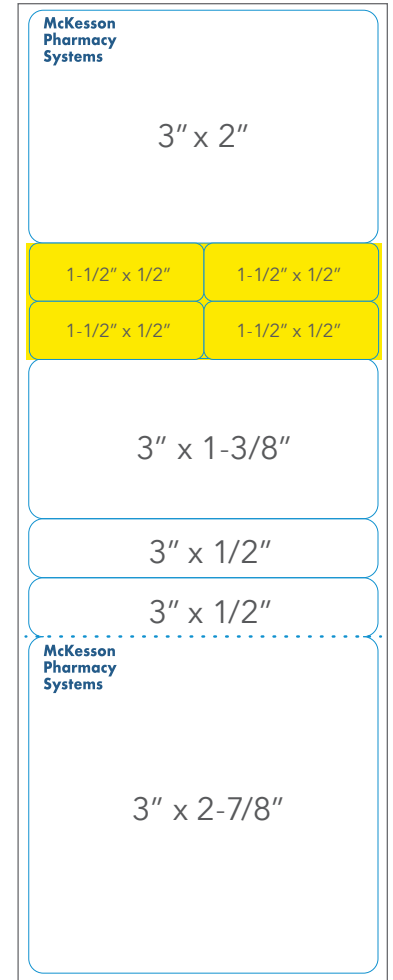

**DTRX-799** **2 6 8 9 10 12**  
 3-1/8" x 8-1/2"  
 250 labels per roll  
 5,000 labels per case

Compatible Systems		
<b>1</b> = EnterpriseRx	<b>5</b> = Datascan	<b>9</b> = OPUS
<b>2</b> = Liberty	<b>6</b> = DigitalRx	<b>10</b> = PioneerRx
<b>3</b> = Express Rx	<b>7</b> = HBS	<b>11</b> = QS1
<b>4</b> = ComputerRx	<b>8</b> = Micro Merchant	<b>12</b> = Rx30

# Direct Thermal Rx Labels

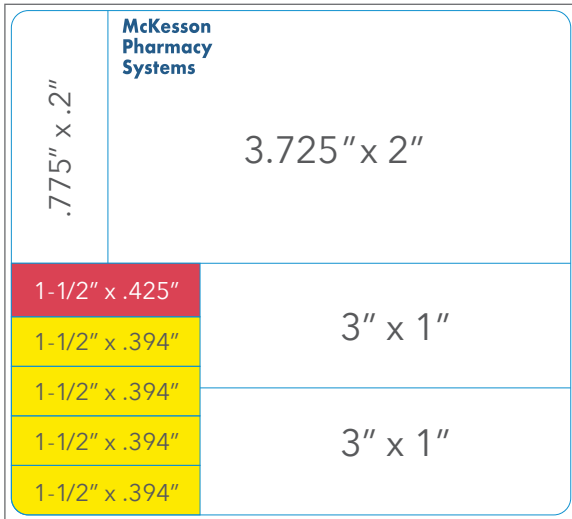

**DTRX-1** ① ②  
 4" x 4-1/2"  
 600 labels per roll  
 7,200 labels per case

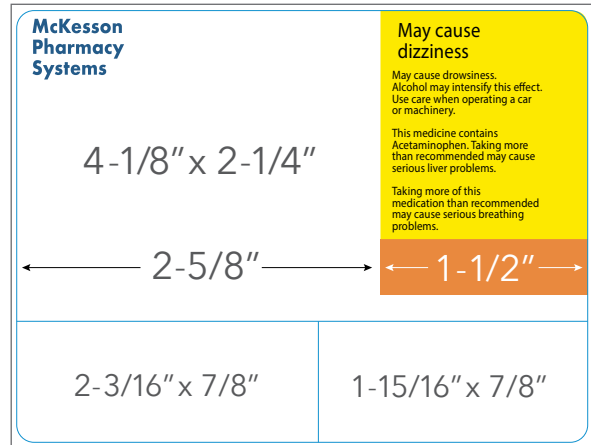

**DTRX-2** ① ②  
 4-1/8" x 3-1/8"  
 925 labels per roll  
 11,100 labels per case

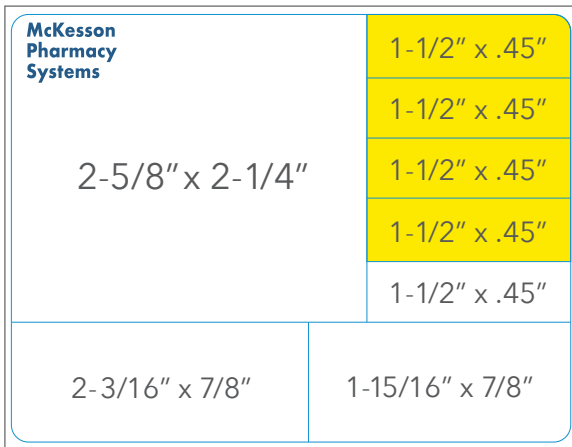

**DTRX-3** ① ②  
 4-1/8" x 3-1/8"  
 925 labels per roll  
 11,100 labels per case

Compatible Systems		
① = EnterpriseRx	⑤ = Datascan	⑨ = OPUS
② = Liberty	⑥ = DigitalRx	⑩ = PioneerRx
③ = Express Rx	⑦ = HBS	⑪ = QS1
④ = ComputerRx	⑧ = Micro Merchant	⑫ = Rx30

# Direct Thermal Rx Labels

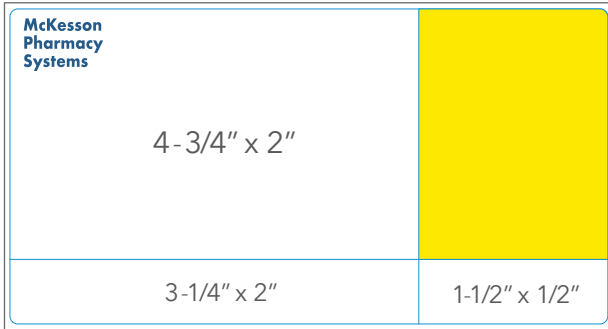

**DTRX-8** ① ② 600 labels per roll  
4-3/4" x 2-1/2" 9,000 labels per case

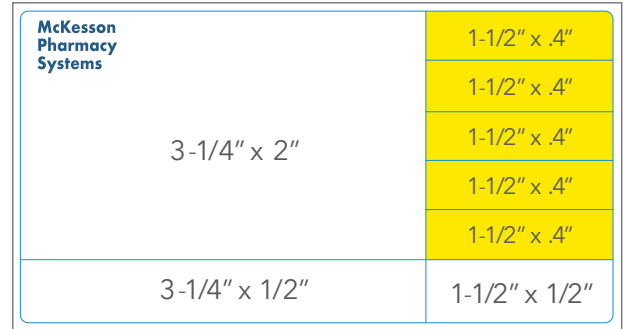

**DTRX-9** ① ② 600 labels per roll  
4-3/4" x 2-1/2" 9,000 labels per case

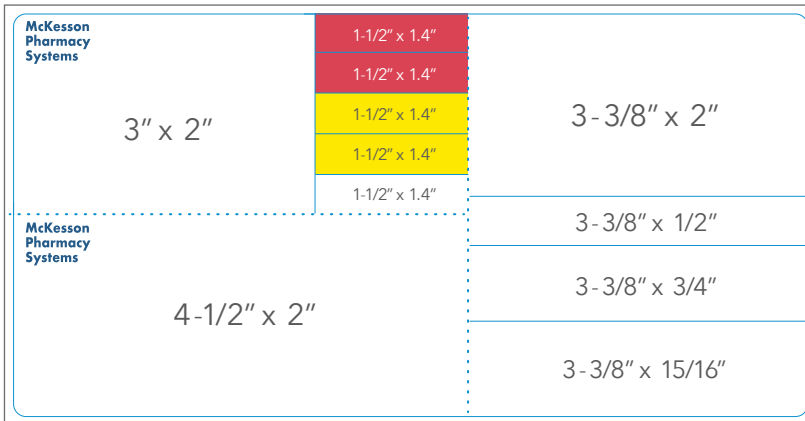

**DTRX-11** ② ④ ⑦ ⑪ ⑫ 320 labels per roll  
7-7/8" x 4" 5,760 labels per case

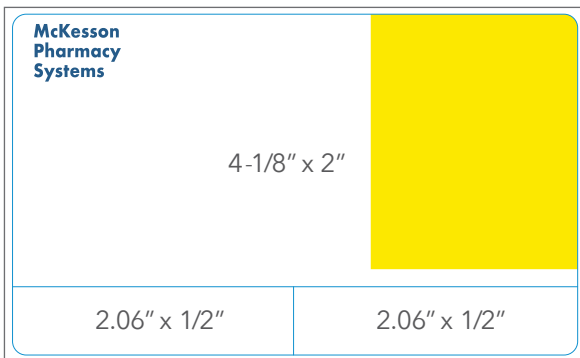

**DTRX-14** ① ② 1,100 labels per roll  
4-1/8" x 2-1/2" 13,200 labels per case

Compatible Systems		
① = EnterpriseRx	⑤ = Datascan	⑨ = OPUS
② = Liberty	⑥ = DigitalRx	⑩ = PioneerRx
③ = Express Rx	⑦ = HBS	⑪ = QS1
④ = ComputerRx	⑧ = Micro Merchant	⑫ = Rx30



# Full Page Laser Rx Labels

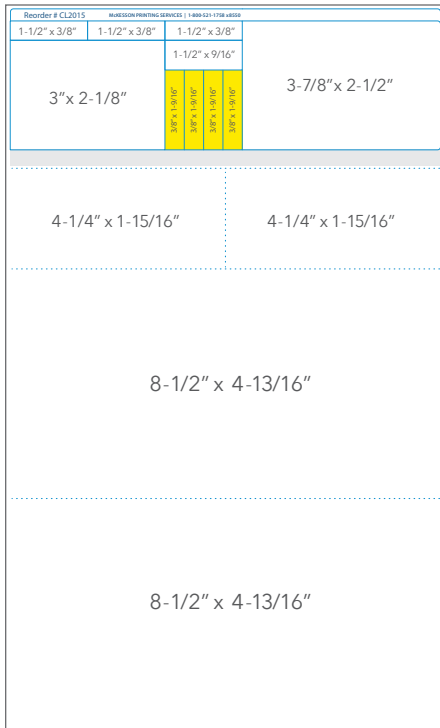

**CL2015 Full Page Label**

8-1/2" x 14" • 1,000 per carton

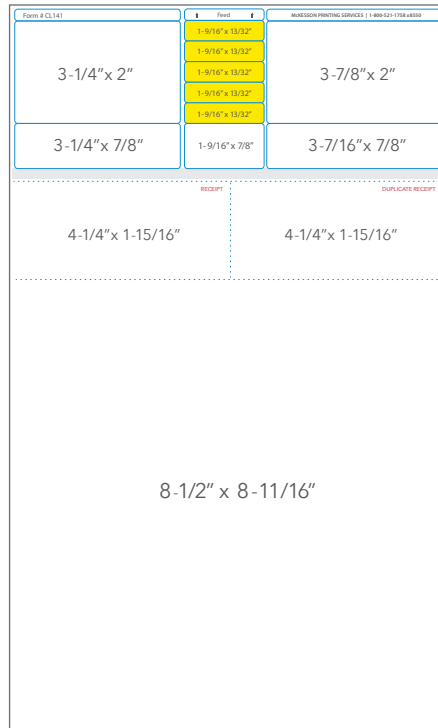

**CL141 Full Page Label**

8-1/2" x 14" • 1,000 per carton

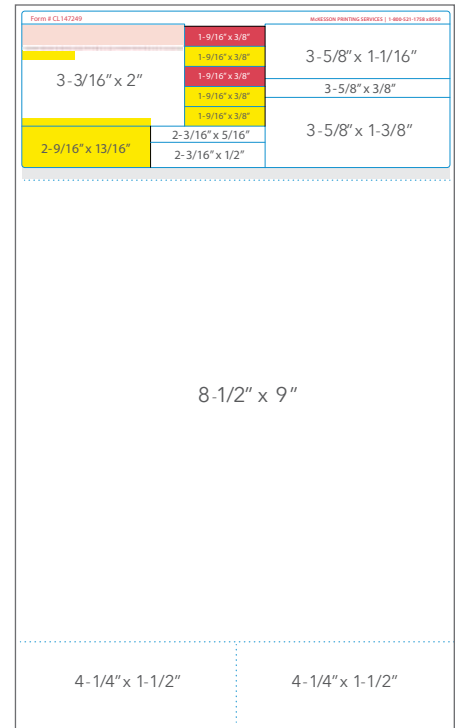

**CL147249 Full Page Label**

8-1/2" x 14" • 1,000 per carton

**Please Note:**

Federal regulations mandate that Patient Information Leaflets be printed with a font size of 10 or larger. For this reason, it should be expected that the entire Patient Information Leaflet will not be printed on your label and additional pages will be required to accommodate the full text of the leaflet.

Compatible Systems		
1 = EnterpriseRx	5 = Datascan	9 = OPUS
2 = Liberty	6 = DigitalRx	10 = PioneerRx
3 = Express Rx	7 = HBS	11 = QS1
4 = ComputerRx	8 = Micro Merchant	12 = Rx30

# Full Page Laser Rx Labels

McKesson Printing Services   1.866.950.8738		Form # CL235887
3" x 2"	3-3/16" x 2"	
3" x 11/16"	2-3/16" x 11/16"	3-3/16" x 11/16"
5-7/8" x 7-7/8"		
2-5/8" x 3-7/8"		
2-5/8" x 4"		

**CL235887 Full Page Label**  
8-1/2" x 11" • 1,000 per carton

McKesson Printing Services   1.866.950.8738		Form # CL205418
3-3/16" x 2"	3-5/8" x 1-1/16"	
2-9/16" x 1-3/16"	3-5/8" x 3/8"	3-5/8" x 1-3/8"
8-1/2" x 5-13/16"		
4-1/4" x 1-11/16"	4-1/4" x 1-11/16"	

**CL205418 Full Page Label**  
8-1/2" x 11" • 1,000 per carton

McKesson Printing Services   1.866.950.8738		Form # CL141-11
3-1/4" x 2"	3-7/16" x 2"	
3-1/4" x 7/8"	3-7/16" x 7/8"	3-7/16" x 7/8"
8-1/2" x 5-13/16"		
4-1/4" x 1-1/4"	4-1/4" x 1-1/4"	

**CL141-11 Full Page Label**  
8-1/2" x 11" • 1,000 per carton

1

McKesson Printing Services   1.866.950.8738		Form # CL117832
3-1/32" x 2"	3-13/16" x 1-1/2"	
4-1/4" x 2-1/16"	4-1/4" x 2-1/16"	
8-1/2" x 6-5/32"		

**CL117832 Full Page Label**  
8-1/2" x 11" • 1,000 per carton

**Please Note:**

Federal regulations mandate that Patient Information Leaflets be printed with a font size of 10 or larger. For this reason, it should be expected that the entire Patient Information Leaflet will not be printed on your label and additional pages will be required to accommodate the full text of the leaflet.

Compatible Systems		
1 = EnterpriseRx	5 = Datascan	9 = OPUS
2 = Liberty	6 = DigitalRx	10 = PioneerRx
3 = Express Rx	7 = HBS	11 = QS1
4 = ComputerRx	8 = Micro Merchant	12 = Rx30

# Automation Prescription Labels

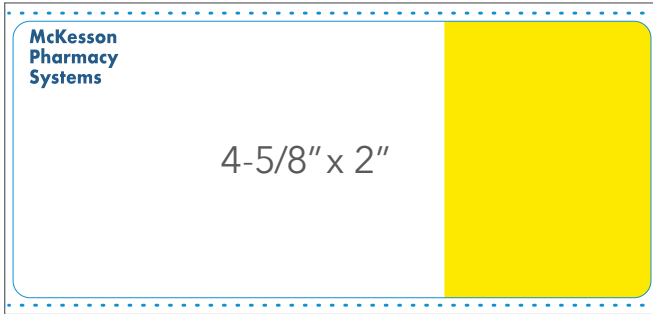

**DTRX-20 Vial Label** 1,000 labels per roll  
3" Core • 4-5/8" x 2" 6,000 labels per case

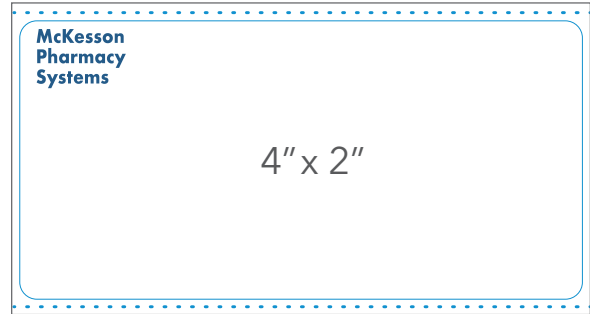

**DTRX-21 Vial Label** 1,150 labels per roll  
3" Core • 4" x 2" 6,900 labels per case

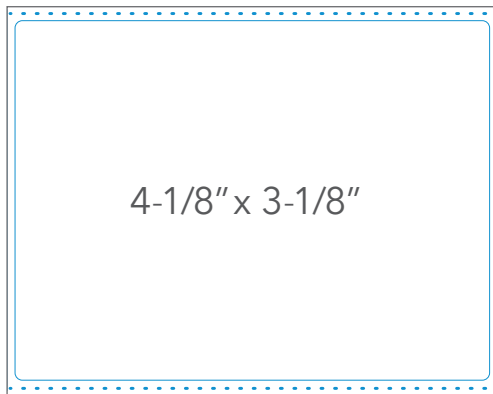

**DTRX-25 Shipping/Bag Label**  
1" Core • 4-1/8" x 3-1/8"  
925 labels per roll  
11,100 labels per case

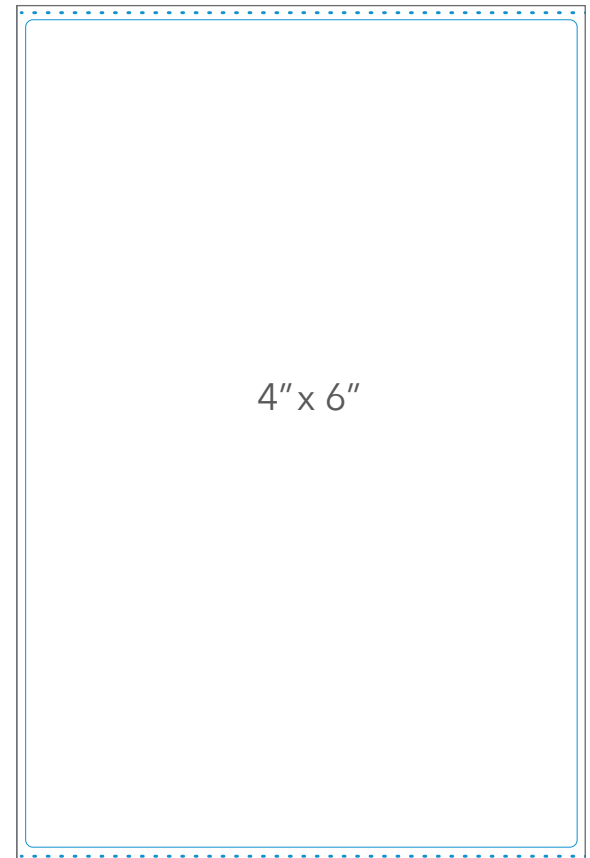

**DTRX-22 Shipping/Bag Label**  
1" Core • 4" x 6"  
450 labels per roll  
5,400 labels per case

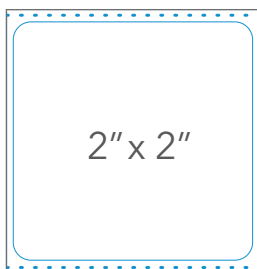

**DTRX-26 Put Away/  
Shelf Label**  
1" Core • 2" x 2"  
1,400 labels per roll  
16,800 labels per case

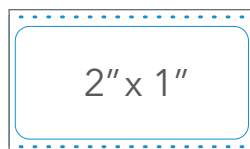

**POSSL Put Away Label**  
1" Core • 2" x 1"  
1,380 labels per roll  
33,120 labels per case

## Back Tags

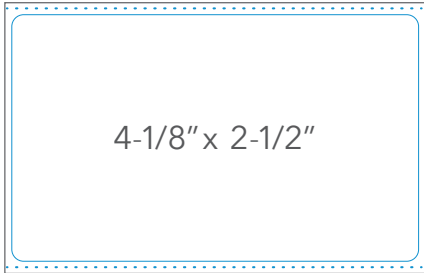

**DTBT-2** 1,150 labels per roll  
4-1/8" x 2-1/2" 13,800 labels per case

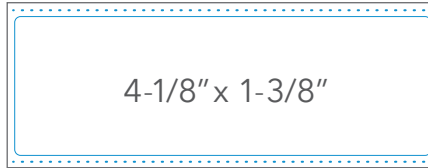

**DTBT-3** 2,000 labels per roll  
4-1/8" x 1 3/8" 12,000 labels per case

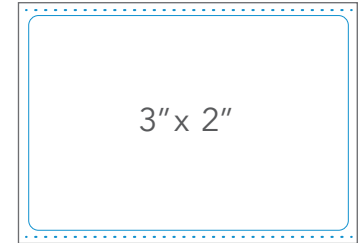

**DTBT-4** 1,400 labels per roll  
3" x 2" 11,200 labels per case

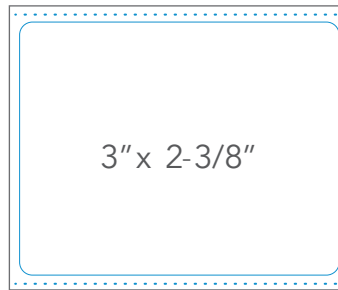

**NAVDTL** 627 labels per roll  
3" x 2-3/8" 7,524 labels per case

## Long Term Care Labels and License Plates

### Thermal Rx Label

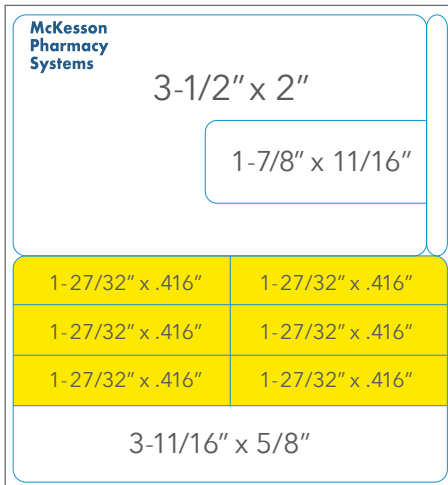

**LTC741** 600 labels per roll  
3-13/16" x 4" 13,200 labels per case

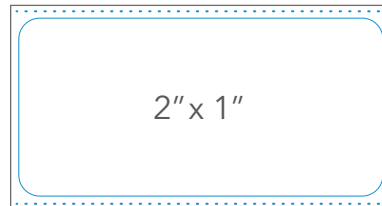

**POSSL**  
**Blister Pack Label**  
2" x 1"  
1,380 labels per roll  
33,120 labels per case

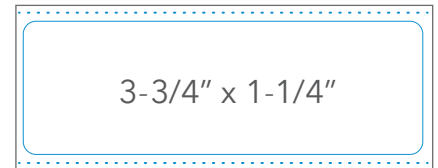

**LP10** – 10-digit license plate  
**LP12** – 12-digit license plate  
3-3/4" x 1-1/4"  
2,500 labels per roll  
25,000 labels per case

# Monograph Receipts

Monograph Receipts are available from stock, or we can customize to your specifications.

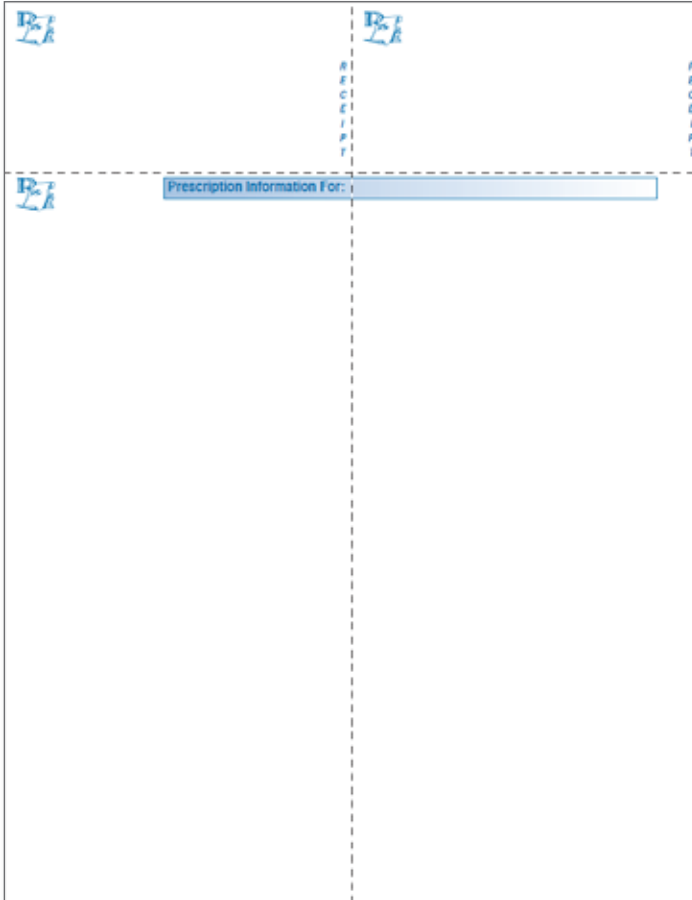

**MRGEN – Stock Item**  
8-1/2" x 11"

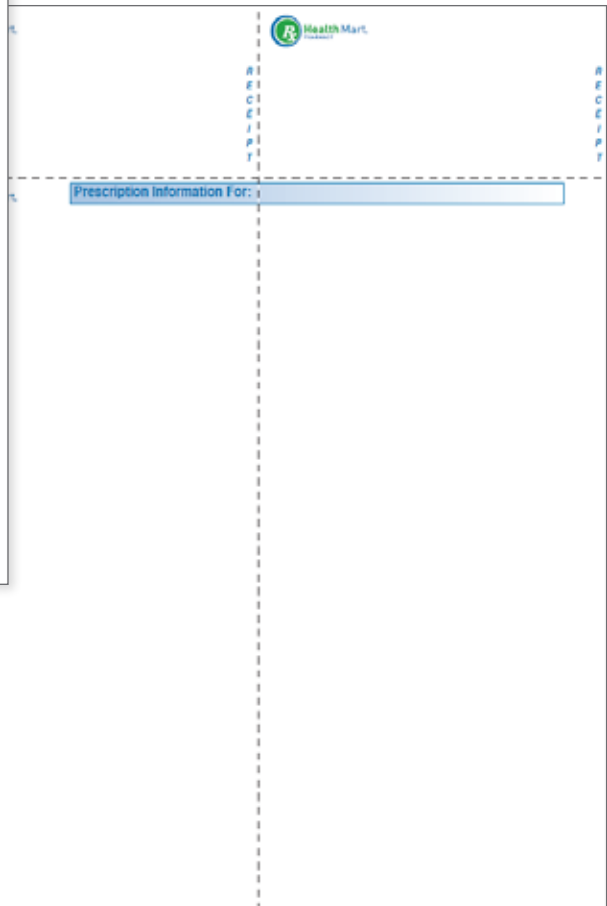

**Customization available!**

# Accounts Receivable Forms and Envelopes

The L-400 Laser A/R Statement form is a white document with a red header and footer. It features a table with columns for 'DESCRIPTION - TISSOT/TECH/REMA', 'QUANTITY', 'UNIT PRICE', and 'TOTAL AMOUNT'. A red arrow points to a 'PLEASE DETACH AND RETURN THIS PORTION WITH YOUR REMITTANCE' instruction. A red box at the bottom right contains the text 'PLEASE DETACH THIS PORTION'.

**L-400 Laser A/R Statement**  
 8-1/2" x 11" • 2,500 per carton  
 • Use envelopes L1WE, L2WE, LL2WE

The LHM-400 Laser A/R Statement form is a white document with a green header and footer. It features a table with columns for 'DESCRIPTION - TISSOT/TECH/REMA', 'QUANTITY', 'UNIT PRICE', and 'TOTAL AMOUNT'. A green arrow points to a 'PLEASE DETACH AND RETURN THIS PORTION WITH YOUR REMITTANCE' instruction. A green box at the bottom right contains the text 'PLEASE DETACH THIS PORTION'. The HealthMart logo is visible in the center.

**LHM-400 Laser A/R Statement**  
 8-1/2" x 11" • 2,500 per carton  
 • Use envelopes L1WE, L2WE, LL2WE



**L1WE Customer Return Envelope for:**  
 L-400 and LHM-400 A/R Statement  
 3-1/4" x 8-1/4" #24 White Wove • Gum Seal  
 2,500 per carton

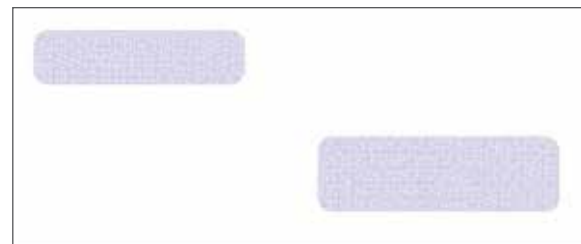

**LL2WE Mailing Envelope for:**  
 L400 and LHM-400 A/R Statement  
 4-1/8" x 9-1/2" #24 White Wove with inside blue tint  
 Latex Seal • 1,000 per carton

**L2WE**  
 L400 and LHM-400 A/R Statement  
 Gum Seal, 2,500 per carton

# Accounts Receivable Forms and Envelopes

**L-500 Laser A/R Statement** 1  
 8-1/2" x 11" • 2,000 per carton  
 • Use envelopes LL2WE567, L2WE567

**L-600 Laser A/R Statement**  
 8-1/2" x 11" • 2,000 per carton  
 • Use envelopes LL2WE567, L2WE567



**LL2WE567 Double Window Envelope for:**  
 L-500 & L-600 Statements 1  
 Latex Seal • 1,000 per carton

**L2WE567 Double Window Envelope for:**  
 L-500 & L-600 Statements 1  
 Gum Seal • 2,500 per carton

Compatible Systems		
1 = EnterpriseRx	5 = Datascan	9 = OPUS
2 = Liberty	6 = DigitalRx	10 = PioneerRx
3 = Express Rx	7 = HBS	11 = QS1
4 = ComputerRx	8 = Micro Merchant	12 = Rx30

# Long Term Care Forms

## Dot Matrix Forms

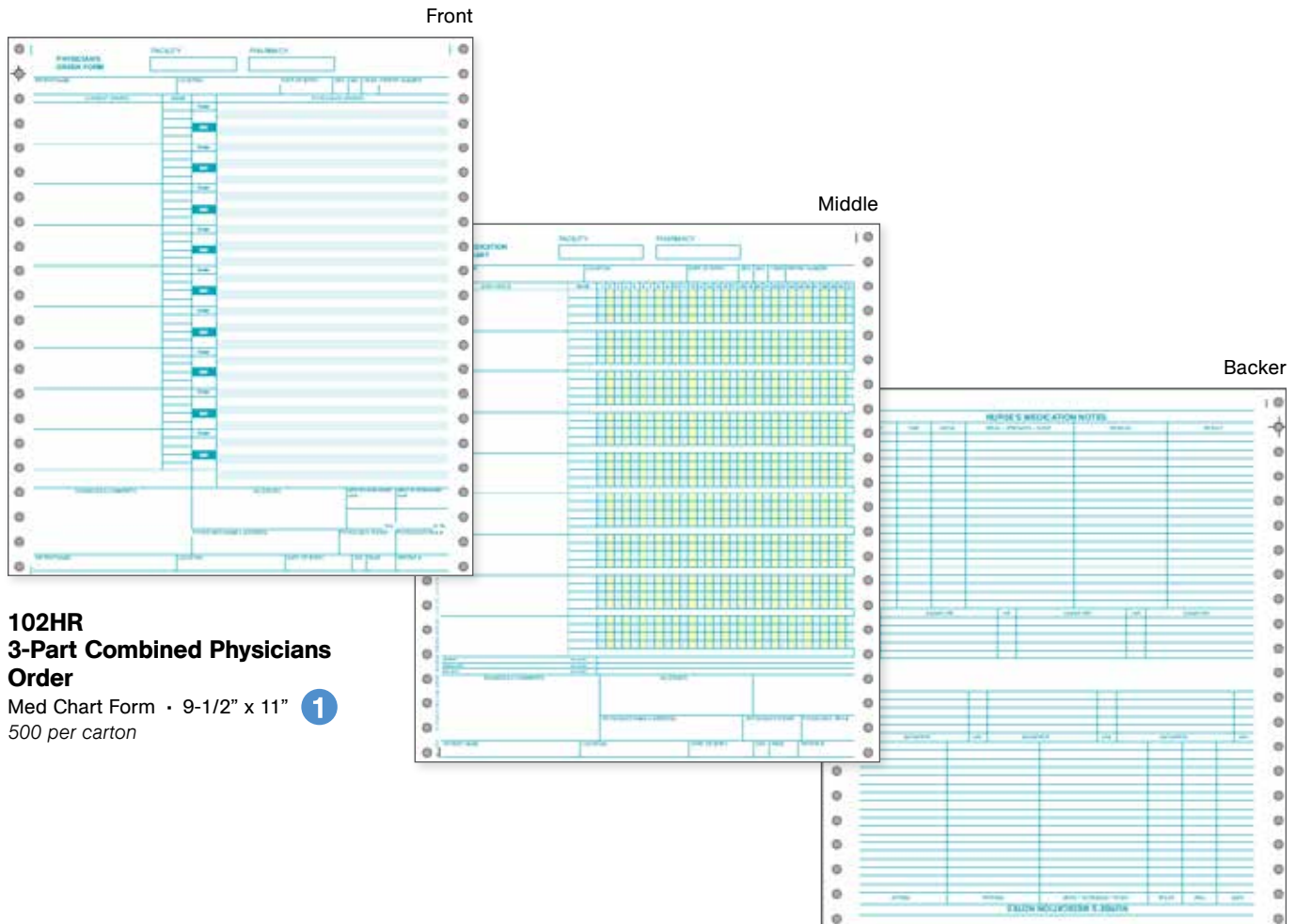

**102HR**  
**3-Part Combined Physicians**  
**Order**  
Med Chart Form • 9-1/2" x 11" **1**  
500 per carton

Compatible Systems		
1 = EnterpriseRx	5 = Datascan	9 = OPUS
2 = Liberty	6 = DigitalRx	10 = PioneerRx
3 = Express Rx	7 = HBS	11 = QS1
4 = ComputerRx	8 = Micro Merchant	12 = Rx30



# Long Term Care Forms

## Laser Forms

Front

Backer

**105L Laser Medication Chart**

8-1/2" x 11" • 1,000 per carton



**102L Physician's Order Form**

8-1/2" x 11" • 1,000 per carton



**Compatible Systems**

- |                  |                    |                |
|------------------|--------------------|----------------|
| 1 = EnterpriseRx | 5 = Datascan       | 9 = OPUS       |
| 2 = Liberty      | 6 = DigitalRx      | 10 = PioneerRx |
| 3 = Express Rx   | 7 = HBS            | 11 = QS1       |
| 4 = ComputerRx   | 8 = Micro Merchant | 12 = Rx30      |

# Long Term Care Forms

## Laser Forms

Front

Backer

**106L Laser Treatment Chart**  
8-1/2" x 11" • 1,000 per carton



# Printer Supplies and Toner Cartridges

## Printer Ribbons

<b>POS Register</b>	<b>Okidata</b>
ERC-32	
ERC-35	0491
ERC-41	0590
ERC-43	OKI-320

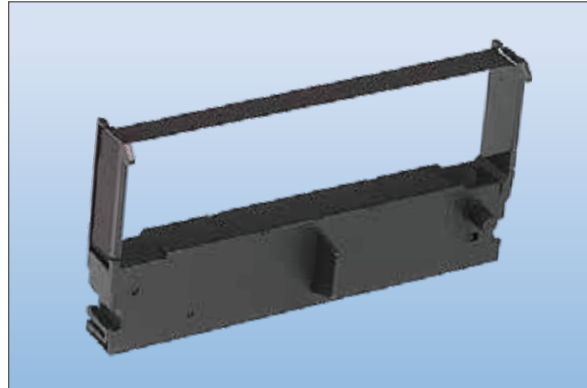

## Printer Toner

### Lexmark MS621 series printer (621)

- MCK621 Refurbished
- Lext621IU Imaging Unit

### Lexmark MS810 series printer (810, 811, 812)

- LEXT810 Refurbished
- LEXT810IU Imaging Unit

### Lexmark T650 series printer (650, 652, 654)

- LEXT650 New
- MCK650 Refurbished



*Additional toner models are available upon request.*

# Supplies and Prescription Pads

## POS Register Tape

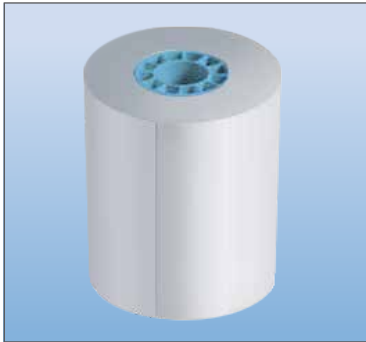

**POSTHERM**

POS Thermal Register Tape  
3-1/8" x 230 ft. Black Image Thermal  
50 rolls per case

## POS Shelf Label

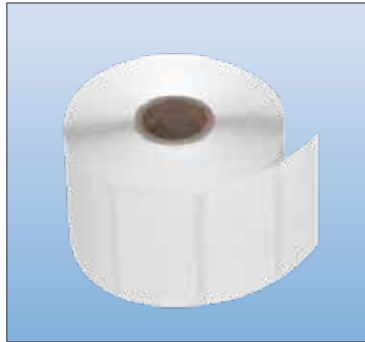

**POSSL**

2" x 1" Direct Thermal label  
with perf.  
1,380 labels per roll  
33,120 labels per case

## Pharmacy Navigator



**NAVDTL**

3" x 2-3/8" Direct Thermal label  
with perf.  
627 labels per roll  
12 rolls per case

## Prescription/Receipt Pads

*(All pads are fully customizable.)*



Item #	Description
PP	Generic Prescription Pad
HMPP	Health Mart Prescription Pad
PPTR	Generic Prescription Pad (tamper resistant)
LRP	Laser Receipt Pad
100 sheets per pad • 50 pads per case	

# Prescription Bags

## Stock Rx Bags

2,000 per carton • Minimum order: 1 carton



**SBHM5**  
5" x 2" x 10"

**SB5F**  
5" x 2" x 10"

## Custom Rx Bags



2,000 per carton

Minimum order: 10,000

Price Break Quantities:  
10,000 • 16,000 • 30,000

Orders ship four weeks after  
approval of proof

Item Code	Dimensions
PB3	3-1/2" x 1-1/2" x 9-3/4"
PB5	5" x 2" x 10"
PB7	7" x 10"

## Custom Square Bottom Bags

1,000 per carton

Minimum order: 6,000

Orders ship four weeks after approval of proof



Item Code	Dimensions
SOS1	6" x 3-5/8" x 11"
SOS2	7" x 4-1/4" x 13-1/2"

# Compliance Packaging Supplies

## 31 Day Single-Dose Medication Management System



### Designed with pharmacy workflow efficiency in mind

To meet the needs of today's busy pharmacy, our monthly single-dose card comes in a book-style panel and grid combination with a selection of blister sizes to fit a variety of dosing-regimens. The single-dose card allows for manual preparation that streamlines filling for high-volume pharmacies.

Large top area accommodates all industry standard single-dose medication labels

Custom print your card to showcase your brand and messaging (or to denote the packaging of narcotics)

Measures approx. 9"H x 12"W open; 9"H x 6"W closed

Reorder "ribbon" reminds patients and caregivers to re-fill prescriptions

31 cavities hold a full month's worth of medication

Space to record important dispensing details

Easy-puncture foil provides tamper-evident storage for medication

"Not child resistant" statement is pre-printed

Easy-to-remove liner and permanent adhesive provide a secure seal without requiring a heat seal press

## Manual Unit Dose Cold Seal System

- Large area for applying your pharmacy's label
- Variety of sizes to meet dosage requirements
- Easily view pills and know when to reorder



### 6 Easy Steps for using our Manual Cold Seal System

- Place blister in tray
- Insert blister in card
- Insert pills
- Peel liner to reveal adhesive
- Fold adhesive panel to blister
- Seal using roller

Cards (500 per case)	Blisters (1,000 per case)	Tray	Roller - 4"
CPCARDS31D	CPCVYS31D	CPTRAYS31D	CROLLER

# Compliance Packaging Supplies

## Qube Medication Management System



Qube Multi-Dose compliance packaging is the perfect solution for pharmacies looking to offer patients the help they need in taking their medications as prescribed no matter how complex the regime.

- Easy-to-follow recommendations for use by patients and caregivers
- Custom print your card with up to 9 colors to showcase your brand and messaging
- Clear blisters are easy to check against adjacent medication label to confirm accurate filling
- Easy puncture foil provides tamper-evident storage for medication
- "FDA side effect" and "not child-resistant" statements are pre-printed
- Large inside panel accommodates all industry standard multi-med labels or up to 10 standard 2" x 3" labels
- Larger morning and bedtime cavities hold more medications at the times they're needed most
- Adherence cards provide quick visual confirmation that medication has been taken

### Qube Multi-Dose

- 28 cavities hold an entire week's worth of medications
- Large text depicts what time of day to take medication
- Easy grid system for patients to locate the correct medication pass



Generous cavities easily accommodate multiple medications

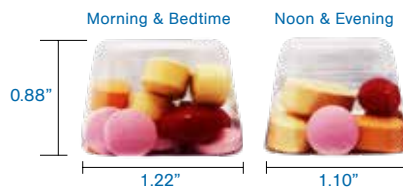

- Easy-to-remove liner and permanent adhesive provide a secure seal without requiring a heat seal press
- Measures 10"H x 6-3/8"W x 7/8"D when completely assembled

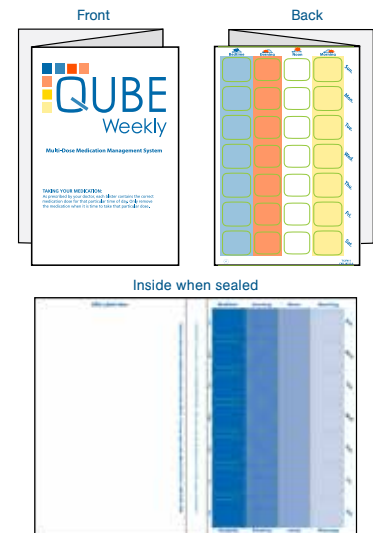

Qube Cards (250 per case)	Qube Blisters (250 per case)	Qube Sealing Tray	Qube Roller
CPCARDM7D	CPCVTYM7D	CPTRAYM7D	CPROLLER

### Qube 31 Day

- 31 cavities hold an entire month's worth of medications
- Printing on inside panel shows day to ensure filling accuracy
- Measures 10"H x 6"W x 7/8"D when completely assembled



Generous cavities easily accommodate multiple medications

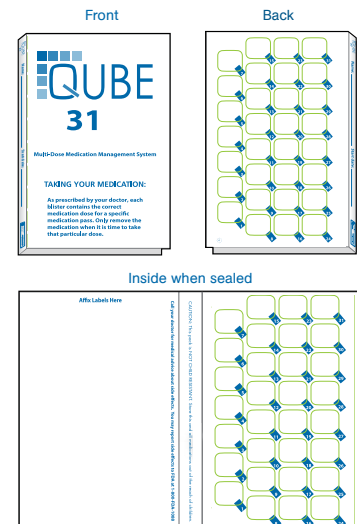
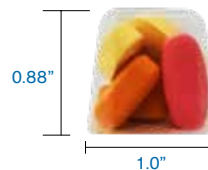

Qube Cards (250 per case)	Qube Blisters (250 per case)	Qube Sealing Tray	Qube Roller
CPCARDM31D	CPCVTYM31D	CPTRAYM31D	CPROLLER

# Label and Art Design

McKesson Printing Services has a fully equipped Graphics Department. We can duplicate your current label, or design a new layout for you. This page shows some of the many logos and art clips you can choose from as part of your label design.

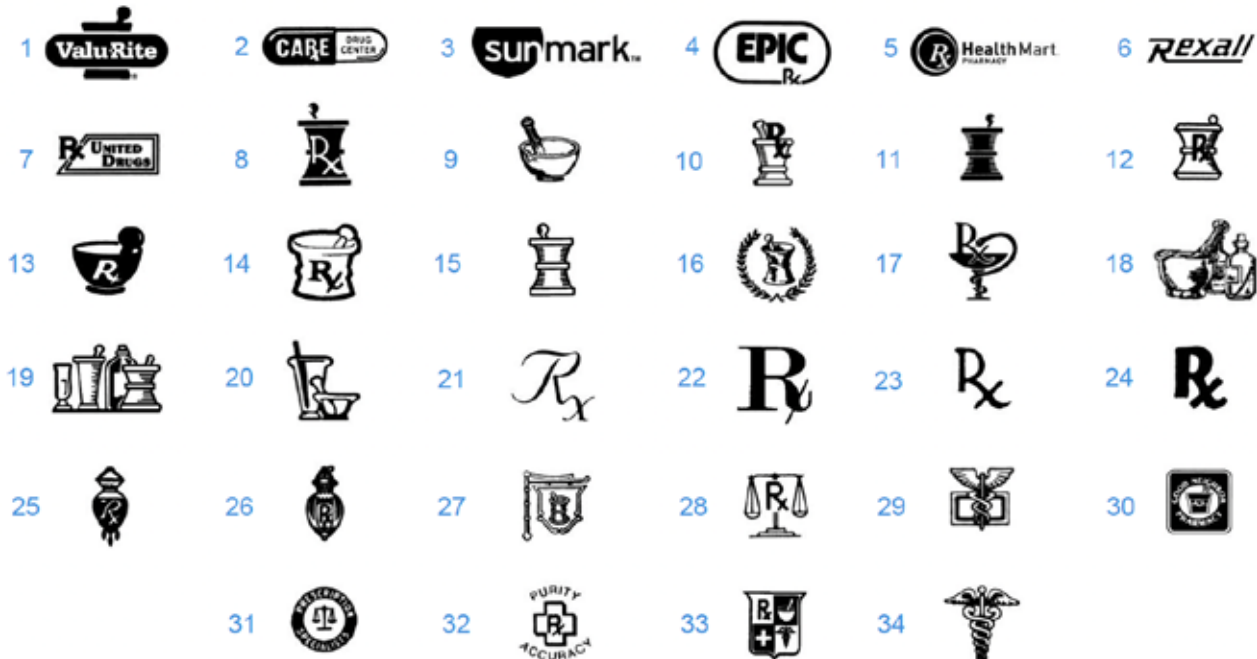

## Popular Ink Colors

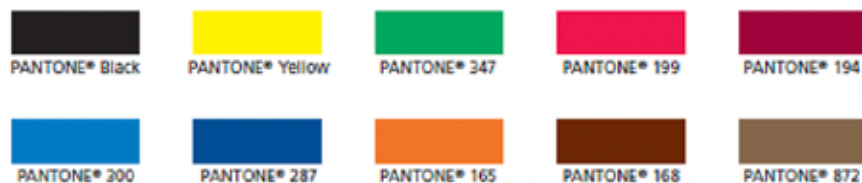

## Health Mart Ink Colors



All PANTONE colors are available.

The colors shown on this page and throughout this manual have not been evaluated by PANTONE for accuracy and may not match the PANTONE Color Standards. Consult current PANTONE Publications for accurate color. PANTONE® is the property of Pantone LLC.



## Convenient Ways for You to Order

### **New Orders:**

**Call:** 800.289.2192, Opt 3

**Email:** [MPTSBusinessServices@McKesson.com](mailto:MPTSBusinessServices@McKesson.com)

### **Reorders:**

**Call:** 866.950.8738

**Fax:** 844.614.6085

**Email:** [MPSPrintingServices@McKesson.com](mailto:MPSPrintingServices@McKesson.com)

